



Description

The RRS-MOD reversing relay/synchronization module enhances the operation of 2 and 4-wire i3 series detectors equipped with a sounder.

Installation Ease

The RRS-MOD includes a Velcro attachment for easy installation into the fire alarm control panel cabinet. A quick-connect harness and color-coded wires simplify connections.

Intelligence

The RRS-MOD's design is flexible to accommodate virtually any application. The RRS-MOD is compatible with both 2 and 4-wire i3 series detectors operating over 12V and 24V systems. The module can be used with either bell/alarm, alarm relay, or NAC outputs, and its field-selectable switch accommodates both coded and continuous alarm signals.

Instant Inspection

To meet fire alarm requirements, the RRS-MOD activates all i3 sounders on a loop when one alarms. Additionally, the RRS-MOD synchronizes the output of the i3 sounders, regardless of whether the panel's alarm signal is continuous or coded, to ensure a clear alarm signal.

Features

- Compatible with 2- and 4-wire i3 detectors equipped with a sounder
- Activates all i3 sounders on a loop when one alarms
- Synchronizes all i3 sounders on the loop for a clear alarm signal
- Can be used with bell/alarm, alarm relay, or NAC outputs
- Includes a field-selectable switch to accommodate both coded and continuous alarm signals
- Allows i3 detector silencing from the panel or keypad
- Operates on 12 and 24-volt systems
- Quick-connect harness and color coded wires facilitate connections

Engineering Specifications

Reversing relay/synchronization module shall be a an i3 Series model number RRS-MOD, listed to Underwriters Laboratories as a smoke detector accessory. The module shall allow all 2-wire and 4-wire i3 Series detectors equipped with a sounder on a loop to sound when one alarms. The module shall provide a switch to toggle between coded mode and continuous mode. When in coded mode, the module shall synchronize the i3 sounders on the loop to mirror the input signal. When in continuous mode, the module shall synchronize the i3 sounders on the loop to the ANSI S3.41 temporal coded pattern. In either coded or continuous modes, the RRS-MOD module shall permit sounders to be silenced at the panel. The RRS-MOD module shall operate between 8.5 and 35 VDC, and shall provide 18 AWG stranded, tinned conductors connected to a quick-connect harness.



Electrical Specifications

Operating Voltage

Nominal: 12/24 V
 Min: 8.5 V
 Max: 35 V

Avg. Operating Current

25 mA

Relay Contact Rating

2 A @ 35 VDC

Physical Specifications

Operating Temperature Range

32°F–131°F (0°C–55°C)

Operating Humidity Range

5 to 85% non-condensing

Wire Connections

18 AWG stranded, tinned, 16" long

Dimensions

Height: 2.5 inches (63 mm)
 Width: 2.5 inches (63 mm)
 Depth: 1 inch (25 mm)

2-Wire System Triggered from Alarm/Bell Circuit:

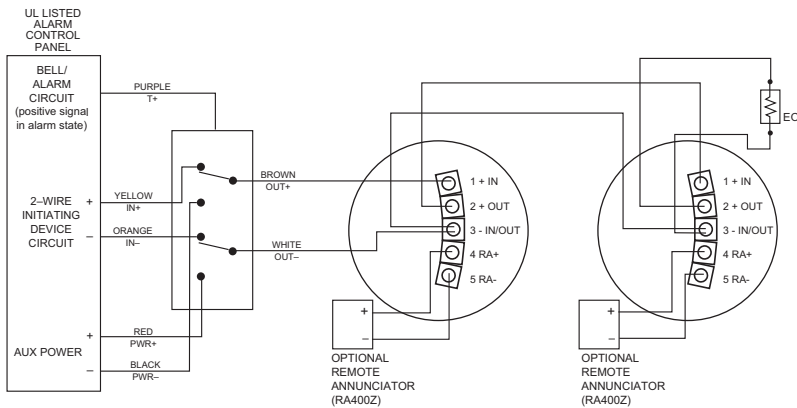

2-Wire System Triggered from Alarm Relay Contact:

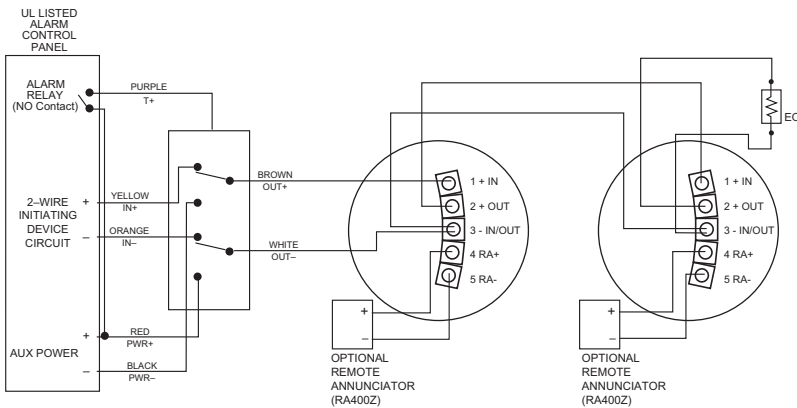

NOTE:

These diagrams represent two common wiring methods. Refer to the RRS-MOD installation manual for additional wiring configurations.

Ordering Information

Model Number

RRS-MOD

Description

Reversing relay/synchronization module for i3 series smoke detectors

NOT TO BE USED FOR INSTALLATION PURPOSES.



Canada

25 Interchange Way
 Vaughan, Ontario L4K 5W3
 Telephone: (905) 660-4655
 Fax: (905) 660-4113

U.S.A.

4575 Witmer Industrial Estates
 Niagara Falls, NY 14305
 Toll Free: (888) 660-4655
 Fax Toll Free: (888) 660-4113

Web page: <http://www.mircom.com>

Email: mail@mircom.com

Distributed by:



ISO 9001:2008
 REGISTERED



CAT. 5149
 Rev. 1