



Description

Mircom's Flex-Net Mass Notification System (MNS) is designed to provide real-time information to all building occupants or personnel in the immediate vicinity of a building during emergency situations. The system allows for real-time information regarding the type of emergency as well as safely instructing people on where to go and what to do.

Mircom's Flex-Net MNS system offers building owners and facility managers with a simple solution to their safety requirements. The system is designed to automatically change as emergency situations change. In addition it is able to manage all mass notification functions, allow responding authorities the ability to override fire alarm notification, issue external voice announcements, and simultaneously distribute different emergency communications on any geographic scale required.

Designed with the industry's most advanced hardware and software, Mircom's Flex-Net MNS system provides reliable and clear audible and visual notification, live voice instruction and Internet based text messaging. In addition it can be easily integrated to other public safety systems for emergency communications to wide area networks.

Mircom's Flex-Net MNS is UL 2572 listed for Mass Notification and complies with NFPA 72-2019 and UFC/DOD standards for emergency communications systems. Based on the proven and reliable Flex-Net Intelligent Network Fire Alarm Control Panel and Audio System the Flex-Net MNS provides a rich feature set that delivers an extensive number of configurable options that allow for flexibility in any environment while reducing the installation and maintenance burden with an easy to install, modular setup.



NYC
Fire Dept



City of Chicago,
High Rise, Class I
and Class II
Acceptable

Features

Mass Notification

- Storage and activation of pre-programmed intelligible voice messages
- Supervision of all Mass Notification (MNS) equipment
- Auxiliary inputs for general paging, background music, or other non-emergency functions
- Tamper resistant enclosures with password-protected features for enhanced access control
- One-Way and Two-Way EVACS capability
- Automatic response to MNS inputs
- Local and remote controls and indicators
- Synchronized evacuation zone signalling
- Voice message priority according to risk analysis and emergency response plan
- Visible notification and strobes support
- Local Operating Console (FX-LOC) that provides on-site monitoring/control of voice and notification appliances
- Large LCD displays
- Fire Alarm Control Panel Interface (FACI)
- Building Management System Interface (BMSI)
- Autonomous Control Unit providing real time status of all FX-LOC units
- UL 2572 Listed for Mass Notification

Fire Alarm Control

- Base system is expandable up to 20 SLCs.
- Advanced Protocol (AP) supports up to 318 devices per SLC (159 sensors & 159 modules)
- MGC Protocol supports up to 240 MIX-4000 devices (240 sensors and modules) per SLC
- Each SLC current capability is 200mA in standby and 400mA in alarm. SLC Maximum line resistance 40 Ohms and maximum line capacitance 0.47uF.
- Four Style Z/Y (Class A/B) Notification Appliance Circuits rated at 1.7 Amps each
- Built-in Ethernet port
- Remote diagnostics via a built-in web server
- UL listed for Smoke Control (UUKL)

Audio Control

- Multi-channel operation
- Distributed audio
- Compatible with 520Hz low frequency signal by Mircom
- 5 hard wire fire fighter telephone channels that can be expanded with intelligent fire phone modules
- 25 or 70 volt system
- Multiple amplifier sizes
- Max. of 180 watts per Integrated Fire & Audio panel
- Expansion to three 360 watts expansion cabinets for a total of 1260 watts of audio power per node

Network Features

- Up to 63 nodes
- Peer-to-peer network communications
- Fully integrated digital network audio and control over a single pair of copper wire or fiber optic cable
- Supports over 5,000 points per node
- Supports over 250,000 points on a single network
- Remote diagnostics via built in web server and standard Ethernet port in every node
- Style 4 (Class B) or Style 6 or 7 (Class A) wiring configuration
- Proprietary Arcnet Network Communications protocol

FLEXNET-MNS Mass Notification Control Modules

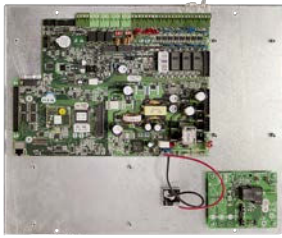

FX-4000MNS Main Network Board

The FX-4000MNS main network board includes four Style Z/Y (Class A/B) NAC circuits. The FX-4000MNS has provisions to mount up to 9 internal adder modules and mounts in the BBX-FXMNS enclosure.



DSPL-420-16TZDS Main Display Module

The DSPL-420-16TZDS Main Display Module provides a 4 line by 20 character backlit LCD display, Common Control buttons and Four Status Queues with selector switches and LEDs for Alarm, Supervisory, Trouble and Monitoring with an additional 16 LED points of annunciation. The DSPL-420-16TZDS occupies one display position in the BBX-FXMNS enclosure.



QMB-5000N Integrated Audio Network Chassis

The QMB-5000N includes the audio and telephone control which consists of an audio card cage designed for mounting the ANC-4000 Audio Network Controller Module, TNC-5000 Telephone Network Controller Module and up to four QAA style audio amplifiers. The QMB-5000N connects to the FX-4000MNS Network fire alarm main board and mounts in the BBX-FXMNS enclosure.



DSPL-2440DS Graphical Main Display Module

The DSPL-2440DS Graphical Main Display Module provides the FLEXNET-MNS with a 24 line x 40 character backlit LCD display, common controls buttons and four status queues with selector switches and LEDs for Alarm, Supervisory, Trouble and Monitor. The DSPL-2440DS occupies one display position in the BBX-FXMNS enclosure.



BBX-FXMNS Enclosure

The BBX-FXMNS enclosure supports the FX-4000MNS Network main board, DSPL-XXXX Main LCD display, QMB-5000N audio card cage, QMP-5101NV Master Paging Microphone and QMT-5302NV Master Telephone Handset. In addition the enclosure provides space for additional external modules and internal lobby control modules. The BBX-FXMNS holds up to 40 AH batteries and is available with white (BBX-FXMNS) or red (BBX-FXMNSR) doors.

BBX-FXMNS Dimensions: 61.5"H x 20"W x 9"D



QMP-5101NV Network Master Paging Control Module

The QMP-5101N Network Master Paging Control Module includes the paging microphone and common control indicators. The QMP-5101N Network Master Paging Control Module connects via a ribbon cable to the first QAZT-5348DS or QAZT-5302DS Zoned Selector Panel and to the previous display module. The QMP-5101NV is vertical mount unit that mounts in the BBX-FXMNS enclosure.



DSPL-420DS Main Display Module

The DSPL-420DS Main Display Module provides the FLEXNET-MNS with a 4-line by 20-character backlit LCD display, Common Controls buttons and Four Status Queues with selector switches and LEDs for Alarm, Supervisory, Trouble and Monitor. The DSPL-420DS occupies one display position in the BBX-FXMNS enclosure.



QMT-5302NV Network Master Firefighters' Telephone Control Module

The QMT-5302NV includes the Master Telephone Handset and common control indicators. The QMT-5302NV supports the QAZT-5302DS Paging and Telephone selector modules. The QMT-5302NV is a vertical mount unit that mounts in the BBX-FXMNS enclosure.

Fire Network Controller Modules

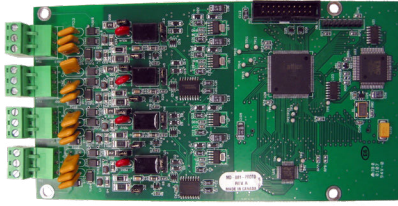

FNC-2000 Fire Network Controller Module

The FNC-2000 provides network capability to the system. One Fire Network Controller Module is required per network node panel. In addition the FNC-2000 provides an interface for adding an optional FOM-2000-UM Fiber Optic Network Adder Module. The FNC-2000 mounts in the FLEXNET-MNS.



FOM-CONN-MM



FOM-CONN-SM

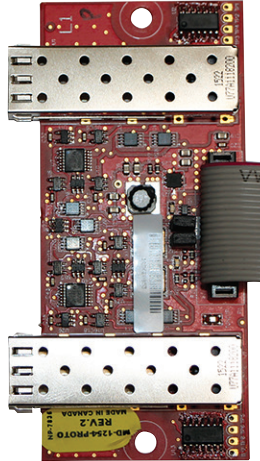

FOM-2000-UM

FOM-2000-UM Fiber Card Universal Mode

Allows for single-mode or multi-mode fibre optic communication on a Flex-Net network. Add FOM-CONN-SM and FOM-CONN-MM

FOM-CONN-MM Fiber Optic Connector Multi-Mode

Fibre Optic Module Connector Multi-mode (pack of 2). Must use a FOM-2000-UM

FOM-CONN-SM Fiber Optic Connector Single-Mode

Fibre Optic Connector Single Mode (pack of 2). Must use a FOM-2000-UM

Adder Auxiliary Modules

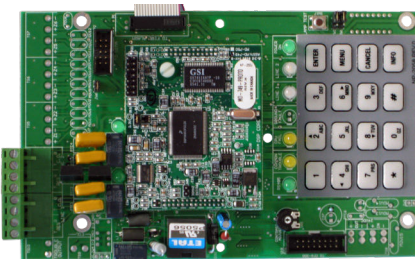

UDACT-300A Digital Alarm Communicator Module

The UDACT-300A Digital Alarm Communicator allows the system to transmit addressable point information to a central station. The UDACT-300A occupies one module slot.

Adder Hardwire Modules

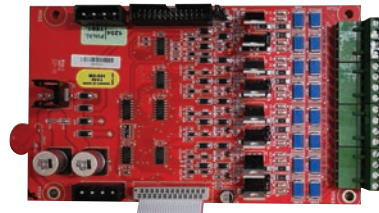

DM-1008A Eight Initiating Circuit Module

The DM-1008A provides 8 Style B (Class B) or 4 Style D (Class A) Initiating Circuits configurable for Alarm, Supervisory or Trouble zones. The DM-1008A occupies one module slot.

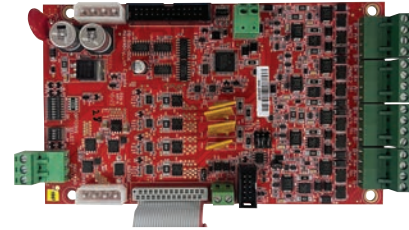

SGM-1004S Four Notification Appliance Circuit Output Module with Built-in Synchronization

The SGM-1004S provides up to four indicating circuits each rated at regulated 24 VDC/FWR 1.7 Amps (5 Amps maximum per SGM-1004S) to signal devices such as strobes, bells, horns, etc., and for special applications it is rated at 33 VDC/FWR 2.1 Amps (5 Amps maximum per SGM-1004S). Each of the indicating circuits can be configured as non-silenceable (steady) or silenceable. SGM-1004S enables the compatible fire alarm control panels to have synchronized NAC circuits.



RM-1008A Eight Relay Circuit Module

The RM-1008A provides the system with eight individual configurable relays per module. Each relay provides one Form C contact rated at 28 VDC @1 Amp (resistive load) as well as a Green LED to indicate that the relay is active. The RM-1008A occupies one module slot.

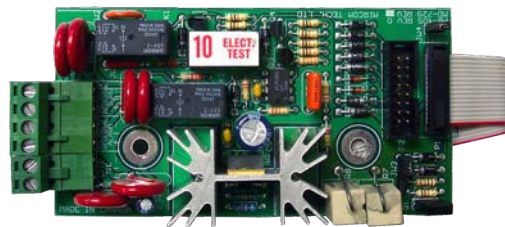

PR-300 Polarity Reversal/City Tie Module

The PR-300 Polarity Reversal/City Tie Module provides the system with a supervised City Tie (24 VDC/200 mA max.) and Polarity Reversal connection (24 VDC (open circuit), 8 mA max. (shorted)). The PR-300 occupies one module slot.

Remote LCD Annunciators

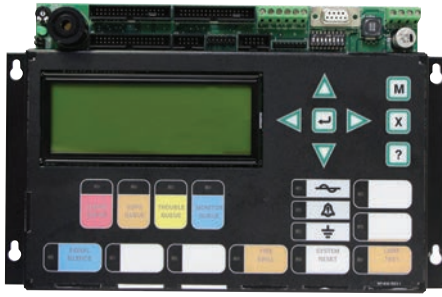

RAXN-4000LCD Remote LCD Annunciator

The RAXN-4000LCD Remote LCD Annunciator is equipped with a 4-line x 20-character back-lit alphanumeric LCD display that provides an exact replica of the main Flex-Net fire alarm control panel display. The RAXN-4000LCD occupies one display position in the BBX-FXMNS, BB-1000 or BB-5000 Series enclosures

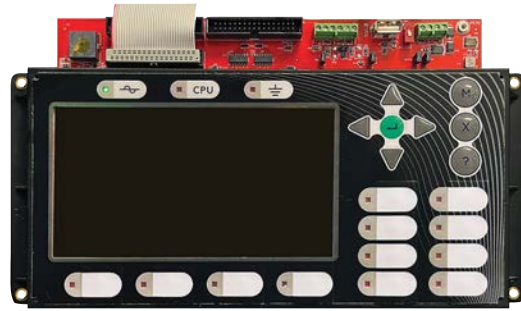

RAXN-4000LCDGC Main Color Display & Network Remote Annunciator

The RAXN-4000LCDGC, Main Color Display and Network Remote Annunciator is equipped with a 16 line x 40 character color graphical LCD display that is used to display eight events per page. Each event is displayed over 2 lines with 40 characters per line allowing emergency information to be displayed in an easy to read format. The RAXN-4000LCDGC occupies one display position in the BBX-FXMNS, BB-1000 or BB-5000 series enclosures.

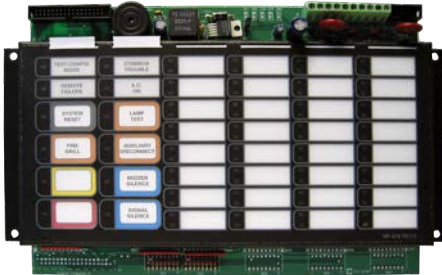

RAM-1032TZDS-CC Conformal Coated Main Remote LED Annunciator

The RAM-1032TZDS-CC Conformal Coated Main Remote LED Annunciator provides common annunciator functions and 32 points of LED annunciation. The RAM-1032TZDS-CC has indicators for A.C. On, Common Trouble and Signal Silence and controls for System Reset, Lamp Test, Fire Drill, Buzzer Silence and Signal Silence. The RAM-1032TZDS-CC occupies one display position in the BB-1001WP(R)A or BB-1002WP(R)A enclosures.



RAX-1048TZDS-CC Conformal Coated Programmable LED Annunciator Module

The RAX-1048TZDS-CC Conformal Coated Programmable LED Annunciator Module provides 48 programmable bi-colored LEDs. The RAX-1048TZDSCC connects to the main panel or either the RAXN-4000LCD or RAM-1032TZDS when mounted remotely. The RAX-1048TZDS-CC occupies one display position in the BB-1002WP(R)A Series enclosures.

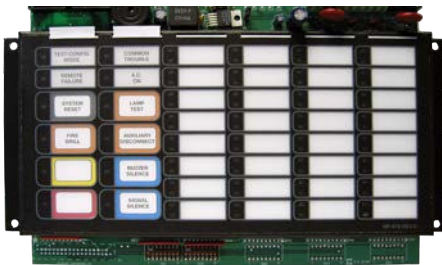

RAM-1032TZDS Main Remote LED Annunciator

The RAM-1032TZDS Main Remote LED Annunciator provides common annunciator functions and 32 points of LED annunciation. The RAM-1032TZDS has indicators for A.C. On, Common Trouble and Signal Silence and controls for System Reset, Lamp Test, Fire Drill, Buzzer Silence and Signal Silence. The RAM-1032TZDS occupies one display position in the BB-1000 or BB-5000 enclosures.



RAX-1048TZDS Programmable LED Annunciator Module

The RAX-1048TZDS Programmable LED Annunciator Module provides 48 programmable bi-colored LEDs. The RAX-1048TZDS connects to the main panel or either the RAXN-4000LCD or RAM-1032TZDS when mounted remotely. The RAX-1048TZDS occupies one display position in the FX-4009-12N, BB-1000 or BB-5000 Series enclosures.

Programmable Modules

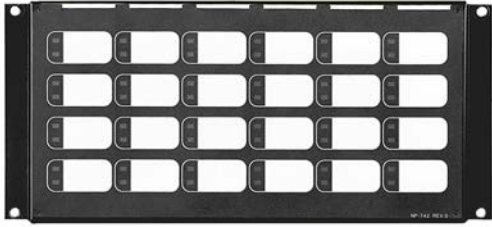

IPS-2424DS Programmable Input Switches Module

The IPS-2424DS provides 24 programmable switches that can be configured for ancillary functions such as zone bypass or added common control functions. The IPS-2424DS connects to the main panel or the RAXN-4000LCD when mounted remotely. The IPS-2424DS occupies one display position in the BBX-FXMNS, BB-1000 or BB-5000 Series enclosures.



FDX-008W/KI Fan Damper Module

The FDX-008W/FDX-008WKI Fan Damper Control Module provides individually programmed circuits which can be used for fan or damper control. The FDX-008W/FDX-008WKI connects to the main panel or the RAXN-4000LCD and occupies one display position in the BBX-FXMNS, BB-1000 or BB-5000 Series enclosures.



IPS-4848DS Programmable Input Switches Module

The IPS-4848 provides 48 programmable switches that can be configured for ancillary functions such as zone bypass or added common control functions. The IPS-4848DS connects to main control unit or the RAXN-4000LCD when mounted remotely. The IPS-4848DS occupies one display position in the BBX-FXMNS, BB-1000 or BB-5000 Series enclosures.

Adder Loop Controller Modules



ALCN-240ISO Isolated Single Loop Adder Module

For MIX-4000 devices, the ALCN-240ISO Isolated Single Loop Adder Module provides one Signaling Line Circuit (SLC) with ground fault detection to the system. The SLC on this loop card supports up to 240 MIX-4000 series devices. The ALCN-240ISO occupies one module slot.

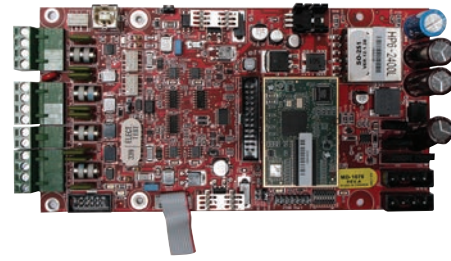

ALCN-4792MISO Isolated Quad Loop Adder Module

The ALCN-4792MISO Isolated Quad Loop Adder Module provides two Signaling Line Circuits (SLC) with ground fault detection to the system consisting of 159 Analog Sensors and 159 Addressable Modules per loop. The ALCN-4792MISO can be expanded with the use of the ALCN-792D Daughter Board Module. The ALCN-4792MISO occupies one module slot.



ALCN-960MISO Isolated Quad Loop Adder Module

For MIX-4000 devices, the ALCN-960MISO Isolated Quad Loop Adder Module provides two Signaling Line Circuits (SLC) with ground fault detection to the system consisting of 240 MIX-4000 devices per loop. The ALCN-960MISO can be expanded with the use of the ALCN-960D Daughter Board Module. The ALCN-960MISO occupies one module slot.

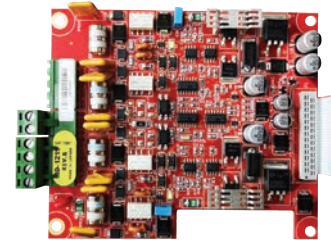

ALCN-792D Daughter board for ALC-4792MISO

The ALCN-792D Daughter Board provides an additional two SLC loops when connected to the ALCN-4792MISO Isolated Quad Loop Controller Module. The daughter board mounts on top of the ALCN-4792MISO.

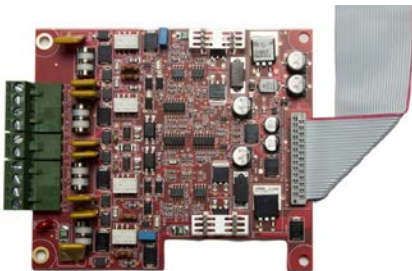

ALCN-960D Daughter board for ALCN-960MISO

For MIX-4000 devices, the ALCN-960D Daughter Board provides an additional two SLC loops when connected to the ALCN-960MISO Isolated Quad Loop Adder Module. The daughter board mounts on top of the ALCN-960MISO.

FLEXNET-MNS Audio and Telephone Network Controller Modules

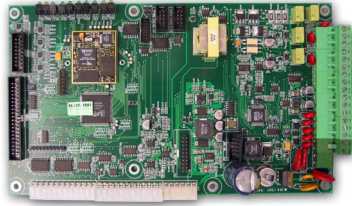

ANC-4000 Audio Network Controller Module

The ANC-4000 Audio Network Controller module is mounted on a metal plate (which is packaged with the FX-4000MNS) and then the plate is mounted into BBX-FXMNS backbox in position 1 of the QMB-5000N Card Cage.

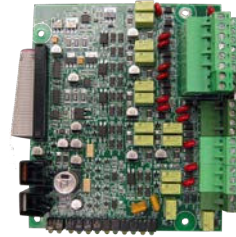

TNC-5000 Telephone Network Controller Module

The TNC-5000 provides five hardwired telephone circuits for the local floor panel with the first circuit configurable for the master telephone handset. The TNC-5000 mounts in the QMB-5000N.

Paging Control Modules for Remote Applications



QMP-5101N Network Master Paging Control Module

The QMP-5101N Network Master Paging Control Module includes the paging microphone and common control indicators. The QMP-5101N Network Master Paging Control Module connects via a ribbon cable to the first QAZT-5348DS or QAZT-5302DS Zoned Selector Panel and to the previous display module. The QMP-5101N occupies one module space in the BB-5000 Series enclosures.

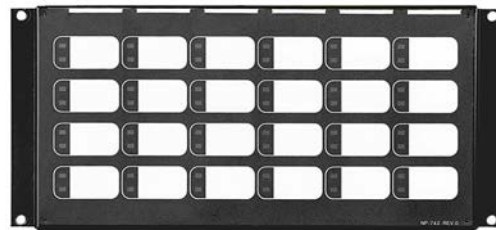

QAZT-5302DS Zoned Paging and Telephone Selector Module

The QAZT-5302DS Zoned Paging and Telephone Selector Module includes 24 zone selector switches and LEDs. The QAZT-5302DS is used with the QMP-5101N Network Master Paging Control module or QMT-5302N Network Master Firefighters' Telephone module. Slide-in labels are provided to label the selector zones. The QAZT-5302DS occupies one module space in the BB-1000 or BB-5000 Series enclosures.

Firefighter Telephone Control Modules



QMT-5302N Network Master Firefighters' Telephone Control Module

The QMT-5302N includes the Master Telephone Handset and common control indicators. The QMT-5302N supports the QAZT-5302DS Paging and Telephone selector modules. The QMT-5302N occupies one module space in the BB-5000 Series enclosures.



QAZT-5348DS Zoned Paging and Telephone Selector Module

The QAZT-5348DS Zoned Paging and Telephone Selector Module includes 48 zone selector switches and LEDs. The QAZT-5348DS is used with the QMP-5101N Network Master Paging Control module or QMT-5348N Network Master Firefighters' Telephone module. Slide-in labels are provided to label the selector zones. The QAZT-5348DS occupies one module space in the BB-5000 Series enclosures.

Annunciator/Programmable Module Enclosures

- BB-1001D: 9"H x 12.75"W x 1.85"D
- BB-1002D: 18"H x 12.75"W x 1.85"D
- BB-1003D: 26.4"H x 12.75"W x 1.85"D
- BB-1008D: 33"H x 22.5"W x 1.85"D
- BB-1012D: 45"H x 22.5"W x 1.85"D

Audio Amplifiers

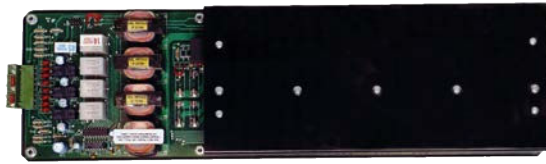

QAA-5415-70 and QAA-5415-25 Quad 15 Watt Amplifiers

The QAA-5415-70 and QAA-5415-25 consist of four 15 watt supervised paging/speaker circuits which can be wired in Class 'B' (Style 'Y') only. The QAA-5415-70 is a 70 Volt amplifier and the QAA-5415-25 is a 25 Volt amplifier. Both models mount in either the QMB-5000N or QMB-5000B card cage and occupy one amplifier slot.

QAA-5230S-70/25 Dual 30 Watt Amplifier

The QAA-5230S-70/25 consists of two 25 or 70 Volt 30 watt amplifiers. Each amplifier has two 15 watt supervised speaker outputs which are used for 'A' 'B' speakers per floor and are wired in Class 'B' (Style 'Y') only. The QAA-5230S-70/25 mounts in either the QMB-5000N or QMB-5000B card cage and occupies one amplifier slot.

QAA-5230-70/25 Dual 30 Watt Amplifier

The QAA-5230-70/25 consists of two 25 or 70 Volt 30 watt supervised paging/speaker circuits which can be wired in Class 'A' (Style 'Z') or Class 'B' (Style 'Y'). The QAA-5230-70/25 mounts in either the QMB-5000N or QMB-5000B card cage and occupies one amplifier slot.

QAA-5160-70/25 60 Watt Amplifier

The QAA-5160-70/25 consists of one 25 or 70 Volt 60 watt supervised paging/speaker circuit which can be wired in Class 'A' (Style 'Z') or Class 'B' (Style 'Y'). The QAA-5160-70/25 mounts in either the QMB-5000N or QMB-5000B card cage and occupies one amplifier slot.

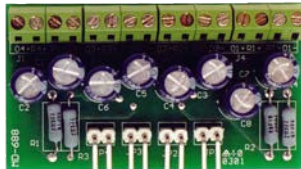

QAA-4CLA Class 'A' (Style 'Z') Converter Module

The QAA-4CLA converts each of the four Class 'B' (Style 'Y') outputs on a QAA-5415-70 or QAA-5415-25 Amplifiers to Class 'A' (Style 'Z'). The module attaches to the bottom of the amplifier. One QAA-4CLA is required for each amplifier.

QAA-4CLAS Class 'A' (Style 'Z') Converter Module

The QAA-4CLAS converts each of the four Class 'B' (Style 'Y') outputs on a QAA-5230S-70/25 or QAA-5230S-525-70/25 Amplifier to Class 'A' (Style 'Z'). The module attaches to the bottom of the amplifier. One QAA-4CLAS is required for each amplifier.

QAA 5415-70 or QAA-5415-25 Wiring Diagram

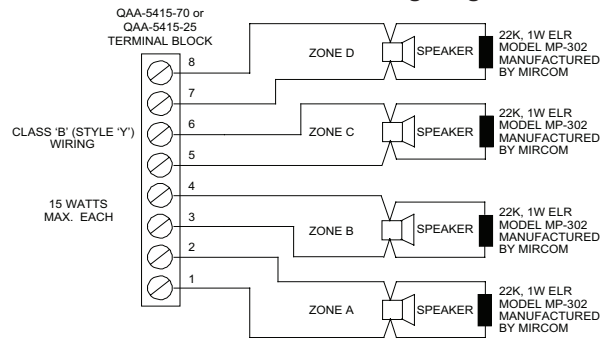

QAA-5230S-70/25 Wiring Diagram

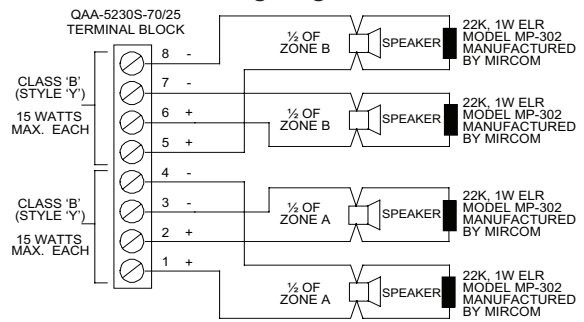

QAA-5230-70/25 Wiring Diagram

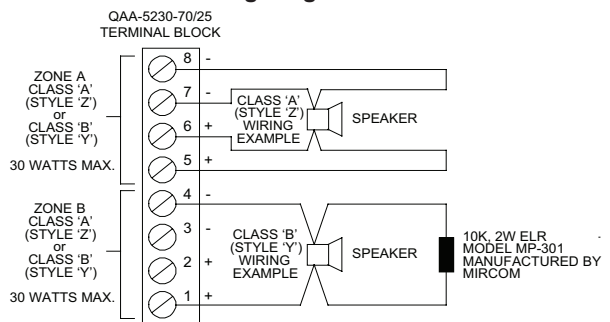

QAA-5160-70/25 Wiring Diagram

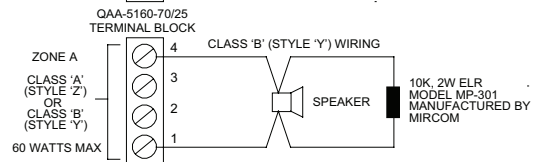
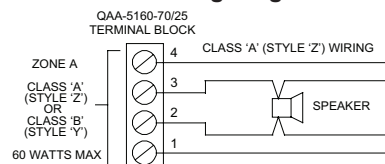

QAA-4CLA and QAA-4CLAS Connection Diagram

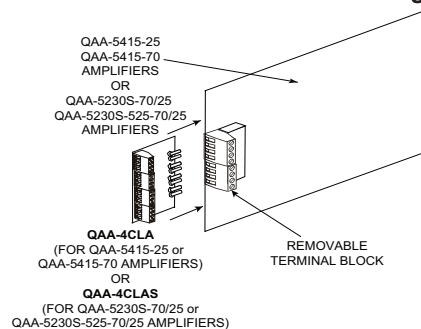

Network System Expansion Enclosures



FX-4009-12N Large Network Main Control Unit

The FX-4009-12N Large Network Main Control Unit consists of a base fire alarm panel with one isolated intelligent Signaling Line Circuit (SLC) Style 4, 6 or 7, Four Style Z/Y (Class A/B) NAC circuits, a 4 line by 20 character LCD display and a 12 Amp power supply. The FX-4009-12N has space to mount the FNC-2000 Fire Network Controller Module, ANC-4000 Audio Network Controller Module, TNC-5000 Telephone Network Controller Module and provision to mount up to 4 adder modules. The FX-4009-12N mounts in a BB-5000 Series enclosure and supports Audio Lobby Control modules, Fire Fighter's Lobby Control modules and FX-4000 Internal Annunciator / Programmable modules.



ECX-0012 Expander Chassis

The ECX-0012 Expander Chassis for the FX-4009-12N supports up to 12 adder modules and has space for 2 internal annunciator modules. The ECX-0012 mounts in the BB-5000 series enclosures.



QBB-5001 Audio Backbox

The QBB-5001 holds one QMB-5000B Audio Motherboard and Card Cage, one QPS-5000N Audio Power Supply, one QBC-5000N Audio Battery Charger and up to 40 Ah batteries.

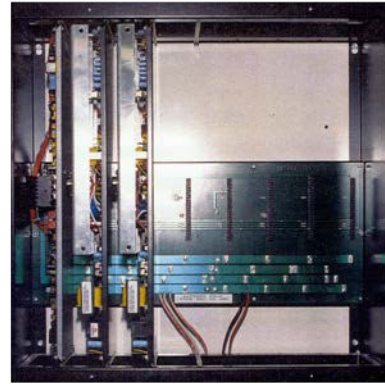

QMB-5000B Audio Motherboard and Card Cage

The QMB-5000B supports 7 QAA style audio amplifiers. The QMB-5000B requires one QPS-5000N Audio Power Supply and one QBC-5000N Audio Battery Charger and mounts in the QBB-5001 Audio Backbox.



QPS-5000N Audio Power Supply

The QPS-5000N supports up to 360 watts and mounts in the QBB-5001 Audio backbox.

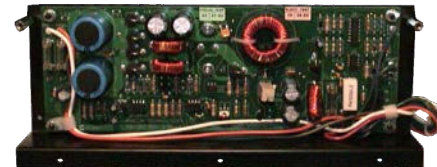

QBC-5000N Audio Battery Charger

The QBC-5000N will charge up to 65 Ah batteries and mounts in QBB-5001 Audio Backbox.

Note: The QBB-5001 Audio Backbox will hold up to 40 Ah batteries. Larger batteries will require a BC-160 Battery Cabinet.

Enclosures



BB-5008 BB-5014
(Displays sold separately)

BB-5008 / BB-5014 Enclosures

The BB-5008 and BB-5014 lobby enclosures support the FX-4009-12N and provide space for internal lobby control modules. The cabinets hold up to 24 AH batteries. The door and chassis hardware are ordered separately.

Model	Dimensions
BB-5008	36" H x 30" W x 7" D
BB-5014	60" H x 30" W x 7" D



DOX-5008MB DOX-5014MB

DOX-5008MB / DOX-5014MB Doors

The DOX-5008MB and DOX-5014MB mounts on the BB-5008 and BB-5014 backbox. The door features the universal CAT-30 lock.



BB-1001WP(R)A – Outdoor Weather Protected Enclosure

The BB-1001WP(R)A is a complete enclosure that comes with either a RED or WHITE door, a black back-box, two keys and a durable lock at the top of the door. The door comes hinged to the bottom side of the box for added weather protection. The box is capable of handling one RAM-1032TZDS-CC Main Annunciator Chassis which provides up to 32 points of annunciation. RAM-1032TZDS-CC is ordered separately conform with the UL, ULC installation requirements.

Note: there is no need for thermostat or heater. RAM-1032TZDS-CC must be ordered separately to match UL, ULC installation requirements.

Dimensions	11-5/32" H x 12-15/16" W x 3-1/2" D (283mm x 329mm x 89mm)
Rated for Outdoor Environment	+50°C to -40°C (-122°F to -40°F)
Wet Location	95% R.H. @60°C



BB-1002WP(R)A – Outdoor Weather Protected Enclosure

The BB-1002WP(R)A is a complete enclosure that comes with either a RED or WHITE door, a black back-box, two keys and a durable lock at the top of the door. The door comes hinged to the bottom side of the box for added weather protection. The box is capable of handling one RAM-1032TZDS-CC Main Annunciator Chassis which provides up to 32 points of annunciation and one RAX1048TZDS-CC Adder Annunciator, which provides up to 48 points of annunciation. RAM-1032TZDS-CC and RAX1048TZDS-CC are ordered separately to match the UL, ULC installation requirements.

Note: there is no need for thermostat or heater. RAM-1032TZDS-CC and RAX-1048TZDS-CC must be ordered separately to match UL, ULC installation requirements.

Dimensions	17-15/16" H x 12-15/16" W x 3-1/2" D (456mm x 329mm x 89mm)
Rated for Outdoor Environment	+50°C to -40°C (-122°F to -40°F)
Wet Location	95% R.H. @60°C

Graphics Software



Open Graphic Navigator (OpenGN)

Open Graphic Navigator (OpenGN) is a centralized fire alarm management system that provides building or campus monitoring. As a powerful integration tool, OpenGN allows operators to monitor remote sites from multiple workstations located anywhere in the world. OpenGN displays monitored buildings and campuses in both 2D and 3D representations, and is highly customizable.

Model	Description
OGN-FLSLIC-ONE	Single Fire Alarm Control Panel License Requires: OGN-KEY (sold separately)
OGN-FLSLIC-EXP	Fire Alarm Control Panel License for 2-9 Connections Requires: OGN-KEY(sold separately)
OGN-FLSLIC-STD	Fire Alarm Control Panel License for 10-99 Connections Requires: OGN-KEY (sold separately)
OGN-FLSLIC-ENT	Fire Alarm Control Panel License for 100+ Connections Requires: OGN-KEY (sold separately)
OGN-KEY	OGN License Key Stick

Power Supply Expansion



INX-10AC Internal Booster Power Supply Module

Mircom's INX-10AC is an Intelligent Booster Power Supply that extends the power capabilities of existing notification appliance circuits as well as provide power for other ancillary devices. The INX-10AC has 10 amps of power and mounts inside the BB-5014 enclosure.

Graphic Annunciator Driver Modules

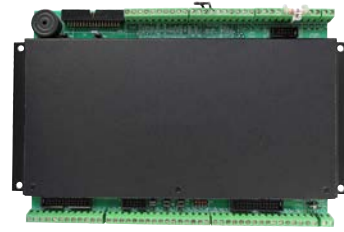

MGD-32 Master Graphic Driver Module

The MGD-32 Master Graphic Driver Module provides common control inputs for the common control switches such as System Reset, Signal Silence, Auxiliary Disconnect, Fire Drill, Lamp Test, Acknowledge and General Alarm. The MGD-32 can also drive up to 32 supervised outputs. These output points are capable of driving LEDs or incandescent lamps. The MGD-32 mounts in a graphic annunciator wallbox or in the BB-5000 enclosures. An external power supply is required for incandescent lamps and lamp test.



AGD-048 Adder Graphic Driver Module

The AGD-048 Adder Graphic Driver Module can be used with the MGD-32 to support an additional 48 supervised outputs. The AGD-048 mounts in a graphic annunciator wallbox or in the BB-5000 enclosures.

Mounting Brackets



M500-BK9 Module Mounting Bracket

The M500-BK9 Module Mounting Bracket mounts inside the BB-5000 Series enclosures and provides space to mount up to nine M500 style intelligent modules.



M500-BK2 Module Mounting Bracket

The M500-BK2 Module Mounting Bracket mounts inside the BBX-FXMNS enclosure and provides space to mount up to two M500 style intelligent modules.

Local Operating Console Components



FX-LOC Lobby Operating Console

The FX-LOC Local Operating Console provides on-site monitoring/control of voice and notification appliances for Mass Notification applications. The FX-LOC enclosure supports one RAXN-4000LCD remote LCD annunciator, a QMP-5101N master paging microphone and one QAZT-5302DS Paging Selector Switch. RAXN-4000LCD, QAZT-5302DS, QAZT-5348DS and QMP-5101N are ordered separately.

Add suffix "R" for red door.
Dimensions: 25"H x 15"W x 5.5"D

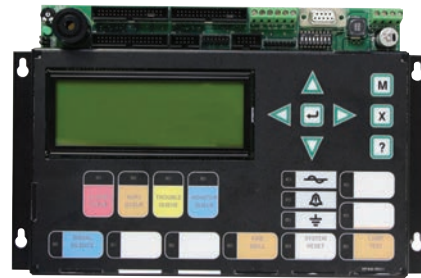

RAXN-4000LCD Remote LCD Annunciator

The RAXN-4000LCD Remote LCD Annunciator is equipped with a 4 line x 20 character back-lit alphanumeric LCD display that provides the exact functions as the FLEXNET-MNS main display. The RAXN-4000LCD occupies one display position in the FX-LOC enclosure.

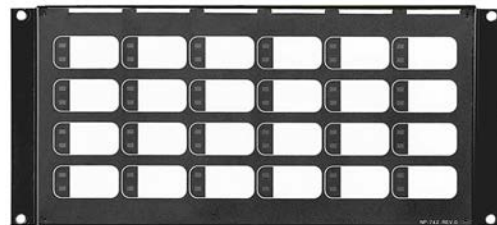

QAZT-5302DS Zoned Paging and Telephone Selector Module

The QAZT-5302DS Zoned Paging and Telephone Selector Module includes 24 zone selector switches and LEDs. The QAZT-5302DS is used with the QMP-5101N Network Master Paging Control module or QMT-5302N Network Master Firefighters' Telephone module. Slide-in labels are provided to label the selector zones. The QAZT-5302DS occupies one module space in the BB-1000 or BB-5000 Series enclosures.



QMP-5101N Network Master Paging Control Module

The QMP-5101N Network Master Paging Control Module includes the paging microphone and common control indicators. The QMP-5101N interconnects between other QMP microphone modules at the FLEXNET-MNS and within the associated FX-LOC units. The QMP-5101N occupies one module space in the FX-LOC enclosure.

Mircom Mass Notification System

Mircom's FleX-Net Intelligent Fire Alarm & Emergency Communications Network is comprised of an Autonomous Control Unit (FLEXNET-MNS) and the FX-LOC Local Operating Console that complies with the UL 2572 requirements for Mass Notification Systems (MNS).

The FX-LOC Local Operating Console along with the FleX-Net Network Fire Alarm provides compliance with the UL 2572 requirements for Mass Notification Systems (MNS) .

The FLEXNET-MNS Autonomous Control Unit is comprised of a BBX-FXMNS enclosure that includes a RAXN-4000LCD Annunciator and a Master Microphone to provide emergency audio. In addition the FLEXNET-MNS is equipped with another RAXN-4000LCD which annunciates the fire alarm system events, a Master Telephone for emergency use and a DSPL-420DS or DSPL-2440DS LCD display which annunciates all system messages (Fire Alarm and Mass Notification). A maximum of seven FX-LOC units can be connected to a FleX-Net MNS node.

Sample In-Building Mass Notification System Configuration

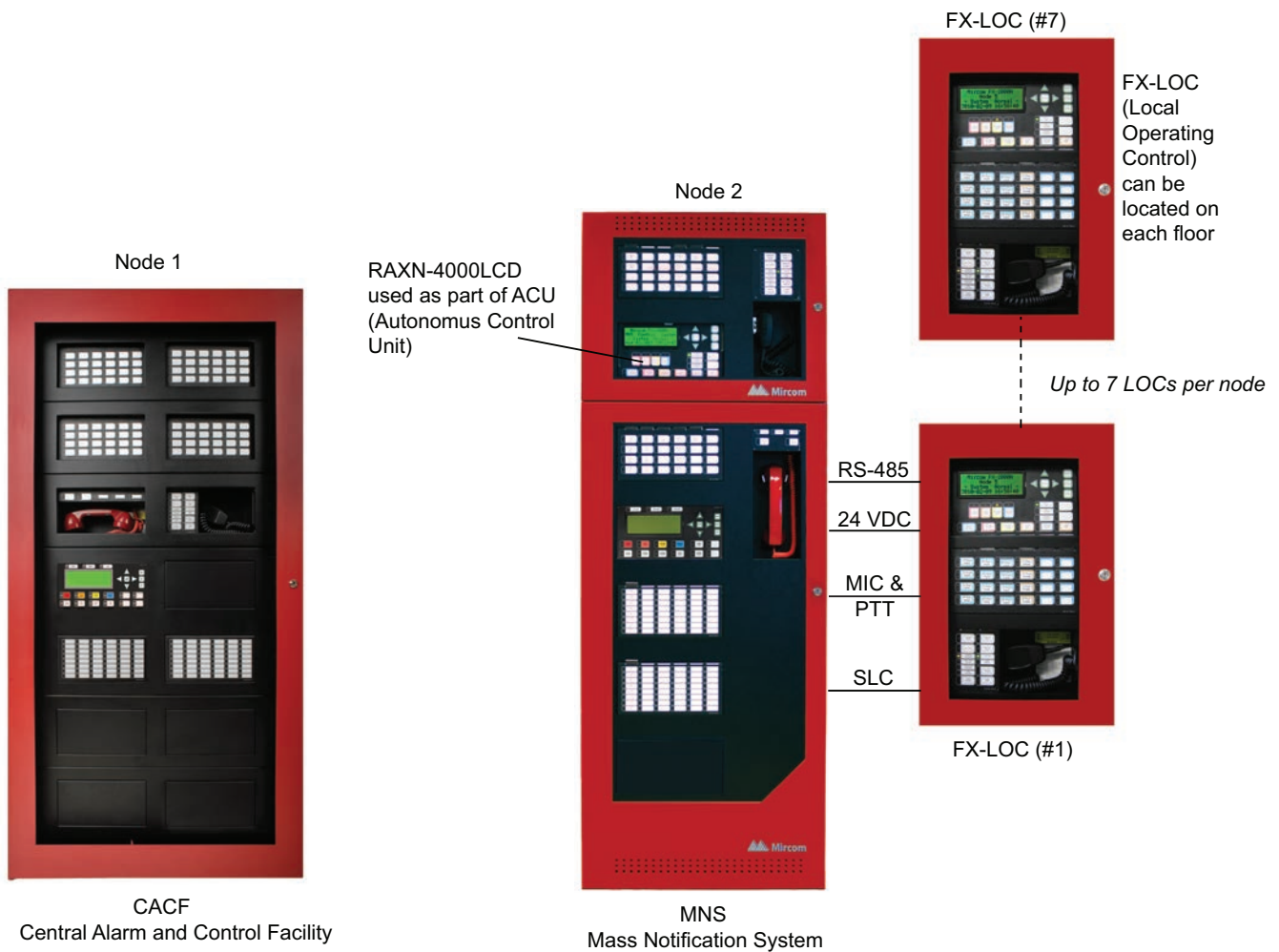

Current Consumption

Model Number	Description	Standby (Amps)	Alarm (Amps)
Fire Alarm Components			
FX-4000MNS	Main Network Board	0.310	0.733
ALCN-240ISO	Isolated Single Loop Controller Module (for MIX-4000 Devices)	0.059	0.080
ALCN-960MISO	Isolated Quad Loop Controller Module (for MIX-4000 Devices)	0.200	0.230
ALCN-960D	Daughter Board for ALCN-960MISO	0.200	0.230
ALCN-4792MISO	Isolated Quad Loop Controller Module (for CLIP & AP Devices)	0.130	0.145
ALCN-792D	Daughter Board for ALCN-4792MISO	0.130	0.145
FNC-2000	Fire Network Controller Module	0.190	0.190
FOM-2000-UM	Fiber Optics Module	0.015	0.015
DM-1008A	8 Initiating Circuit Module	0.080	1 zone active: 0.125 2 zone active: 0.170 4 zone active: 0.275 6 zone active: 0.370 8 zone active: 0.465
SGM-1004S	4 Notification Appliance Circuit Module	0.031	0.096
RM-1008A	8 Relay Circuit Module	0.025	0.150
FDX-008W/KI	Fan Damper Control Module	0.015	0.035
DSPL-420DS	Narrow Display	0.025	0.025
DSPL-420-16TZDS	Narrow Display w/ 16 additional LED Zones	0.010	0.046
DSPL-2440DS	Graphic Display	0.025	0.025
UDACT-300A	Dialer Module	0.045	0.120
PR-300	City Tie Module	0.035	0.300
RAX-1048TZDS	Adder Annunciator Chassis	0.022	1 zone active: 0.026 2 zone active: 0.030 3 zone active: 0.035 4 zone active: 0.039 48 zone active: 0.262
RAM-1032TZDS	Adder Annunciator Chassis	0.050	32 zone active: 0.300
MGD-32	Main Graphic Driver Module	0.035	1.6
AGD-048	Adder Graphic Driver Module	0.035	# of LEDs x 4mA
IPS-2424DS	Programmable Input Switches Module	0.005	0.022
IPS- 4848DS	Programmable Input Switches Module	0.010	0.022
Audio Components			
ANC-4000	Audio Network Controller Module	0.255	0.265
TNC-5000	Telephone Network Controller Module	0.195	0.215
QAA-5160-70/25	1 Zone 60W Amplifier	0.055	0.350
QAA-5230-70/25	2 Zone 30W Amplifier	0.055	0.350
QAA-5230S-70/25	2 Zone 30W Amplifier (split)	0.055	0.350
QAA-5415-70	4 Zone 15W Amplifier, 70V	0.055	0.350
QAA-5415-25	4 Zone 15W Amplifier, 25V	0.055	0.350
QMP-5101N	Horizontal Master Paging Module	0.004	0.012
QMP-5101NV	Vertical Master Paging Module	0.004	0.012
QMT-5302N	Horizontal Master Telephone Module	0.003	0.013
QMT-5302NV	Vertical Master Telephone Module	0.003	0.013
QAZT-5302DS	Paging/Telephone Zone Module	0.005	0.022
QAZT-5348DS	Paging/Telephone Zone Module	0.010	0.022

Electrical Specifications

Fire Alarm Primary Input Power	120V 60Hz / 240V, 50Hz 4 Amps / 2 Amp (primary)
Power Supply Ratings	12 Amps. max. (secondary)
For NAC Circuits	24VDC unfiltered, 10 Amps. max.
Battery Type	24VDC, Gel-Cell/Sealed Lead-Acid
Battery Charging Capability	17-65 AH batteries
Audio Primary Input Power (QPS-5000N)	120 VAC, 60Hz / 240 VAC, 50Hz 12 Amps

Dimensions for Annunciator Module Enclosures

Model	Dimensions
BB-1001D	9"H x 12.75"W x 1.85"D
BB-1002D	18"H x 12.75"W x 1.85"D
BB-1003D	26.4"H x 12.75"W x 1.85"D
BB-1008D	33"H x 22.5"W x 1.85"D
BB-1012D	45"H x 22.5"W x 1.85"D

Environmental

Operating Temperature	32°F to 120°F (0°C to 49°C)
Humidity	10% - 93% non-condensing



NOT TO BE USED FOR INSTALLATION PURPOSES.
THIS INFORMATION IS FOR MARKETING PURPOSES ONLY AND
NOT INTENDED TO DESCRIBE THE PRODUCTS TECHNICALLY.

CAT. 5985
Page 14 of 17

Ordering Information

Model	Description
Mass Notification Control Panels	
FX-4000MNS	FLEXNET-MNS Main Network Board with 12 Amp power supply and 120/240V transformer. Mounts in the BBX-FXMNS enclosure.
QMB-5000N	Integrated Audio Network Control Chassis. Mounts in the BBX-FXMNS enclosure
PS-2040	FLEXNET-MNS Network Fire Alarm and Audio Power Supply (120/240V)
BBX-FXMNS	Black backbox enclosure with white doors for FX-4000MNS. Add suffix 'R' for red doors. Add suffix 'B' for black doors.
DSPL-420DS	4 x 20 Main LCD Display for FX-4000MNS
DSPL-420-16TZDS	4 x 20 Main LCD Display for FX-4000MNS w/ Additional 16 LED Zones
DSPL-2440DS	Graphical Main Display for FX-4000MNS
FX-LOC	Local Operating Console enclosure for FLEXNET-MNS. Add suffix "R" for red door. Add suffix 'B' for black doors.
Paging/Telephone Modules	
QMP-5101NV	Master Network Paging Control Module for FLEXNET-MNS, Vertical Mount. For use in BBX-FXMNS.
QMT-5302NV	Master Network Telephone Module for FLEXNET-MNS, Vertical Mount. For use in BBX-FXMNS.
QMP-5101N	Master Network Paging Control Module
QMT-5302N	Master Network Telephone Control Module
QAZT-5302DS	Paging and Telephone Selector Panel
QAZT-5348DS	Paging and Telephone Selector Panel
Network Controller Modules	
FNC-2000	Fire Network Controller Module
FOM-2000-UM	Allows for single-mode or multi-mode fibre optic communication on a FLEXNET-MNS network. Add FOM-CONN-SM and FOM-CONN-MM
FOM-CONN-MM	Fibre Optic Module Connector Multi-mode (pack of 2). Must use a FOM-2000-UM
FOM-CONN-SM	Fibre Optic Connector Single Mode (pack of 2). Must use a FOM-2000-UM
ANC-4000	Audio Network Controller Module
TNC-5000	Telephone Network Controller Module
Adder Loop Controller Modules	
ALCN-240ISO	Isolated Single Loop Controller Module (for MIX-4000 Devices)
ALCN-960MISO	Isolated Quad Loop Controller Module (for MIX-4000 Devices)
ALCN-960D	Daughter Board for ALCN-960MISO
ALCN-4792MISO	Isolated Quad Loop Controller Module (for CLIP & AP Devices)
ALCN-792D	Daughter Board for ALCN-4792MISO
Adder Hardwire Modules	
DM-1008A	Eight Class B (Style B) or 4 Class A (Style D) Initiating Circuit Module
SGM-1004S	Four Class A/B (Style Z/Y) Notification Appliance Circuit Module (Rated at 1.7 Amps per circuit)
RM-1008A	Eight Relay Circuit Module c/w eight form C relays (Rated for 28 VDC @ 1 Amp max. per relay)
Adder Auxiliary Modules	
UDACT-300A	Digital Alarm Communicator Transmitter/Dialer Module
PR-300	Polarity Reversal and City Tie Module
Remote Annunciators	
RAXN-4000LCD	Remote Network LCD Annunciator c/w 4 x 20 LCD display
RAXN-4000LCDGC	Main Color Display & Network Remote Annunciator
RAM-1032TZDS	Main Remote LED Annunciator c/w 32 Bi-Colored LEDs
RAX-1048TZDS	Programmable LED Annunciator Module c/w 48 Bi-Coloured LEDs and 48 Trouble LEDs
Programmable Modules	
IPS-2424DS	Programmable Input Switches Module c/w 24 selector switches and 24 bi-coloured LEDs
IPS-4848DS	Programmable Input Switches Module c/w 48 selector switches and 48 bi-coloured LEDs
FDX-008W	Fan Damper Control Module provides switch operation of 8 fan damper zones
FDX-008WKI	Fan Damper Control Module provides switch operation of 7 fan damper zones and one keyswitch operation of the 8th fan damper zone

Graphic Annunciator Driver Modules	
MGD-32	Main Graphic Driver Module c/w 32 Supervised Outputs
AGD-048	Adder Graphic Driver Module c/w 48 Supervised Outputs
Audio Amplifiers	
QAA-5415-70	70 Volt Quad 15 Watt Amplifier
QAA-5415-25	25 Volt Quad 15 Watt Amplifier
QAA-4CLA	Class 'A' (Style 'Z') Converter Module for QAA-5415-25 and QAA-5415-70 Amplifiers
QAA-5230S-70/25	25 or 70 Volt Dual 30 Watt Amplifier split 'A' 'B' circuits per floor
QAA-4CLAS	Class 'A' (Style 'Z') Converter Module for QAA-5230S-70/25 and QAA-5230S-525-70/25 Amplifiers
QAA-5230-70/25	25 or 70 Volt Dual 30 Watt Amplifier
QAA-5160-70/25	25 or 70 Volt 60 Watt Amplifier
Graphics Software	
OGN-FLSLIC-ONE	Single Fire Alarm Control Panel License (Price per connection) Requires: OGN-KEY (sold separately) Contact us for non-Mircom panel connections
OGN-FLSLIC-EXP	Fire Alarm Control Panel License for 2-9 Connections (Price per connection) Requires: OGN-KEY(sold separately) Contact us for non-Mircom panel connections
OGN-FLSLIC-STD	Fire Alarm Control Panel License for 10-99 Connections (Price per connection) Requires: OGN-KEY (sold separately) Contact us for non-Mircom panel connections
OGN-FLSLIC-ENT	Fire Alarm Control Panel License for 100+ Connections (Price per connection) Requires: OGN-KEY (sold separately) Contact us for non-Mircom panel connections
OGN-KEY	OGN License Key Stick
Graphics Hardware	
OGN-UL-STD	Industrial Rack Appliance /w UL/ULC Certification
OGN-TWR-STD	Industrial Tower/Rack Appliance /w Long Life & Stability
51-15063-001	22" Class Wide Desktop Monitor UL864 / ULC-S527-11 / UL 2572 Recognized LED Backlit (Monitor for OGN-UL-STD)
ARW-VESP211-KIT	1-port Ethernet Serial Server Kit
ARW-2525-KIT	Industrial 5-PORT Unmanaged POE Switch Kit. Kit includes: 1 X 5-PORT Unmanaged POE Switch and 1 X 75W 48 VDC power supply
Power Supply Module	
INX-10AC	Internal Booster Power Supply Module
Fire & Audio Expansion Components and Enclosures	
FX-4009-12N	Large Network Main Chassis. Mounts in the BB-5000 series enclosures.
ECX-0012	Expander Chassis for the FX-200912NDS. Mounts in the BB-5000 series enclosures.
BB-5008	Lobby Control Wallbox Enclosure. Supports 8 Module Footprints.
DOX-5008MB/R	Door for BB-5008 - "B" for Black and "R" for Red
CCH-5008-PANELKIT	Panel Mounting Kit for BB-5008- CCH-5008-ANNUNKIT
CCH-5008-ANNUNKIT	Annunciator Mounting Kit for BB-5008
BB-5014	Lobby Control Wallbox Enclosure. Supports 14 Module Footprints.
DOX-5014MB/R	Door for BB-5014 - "B" for Black and "R" for Red
CCH-5014-PANELKIT	Panel Mounting Kit for BB-5014
CCH-5014-ANNUNKIT	Annunciator Mounting Kit for BB-5014
QBB-5001	Audio Backbox
QMB-5000B	Audio Motherboard and Card Cage
QPS-5000N	Audio Power Supply (120/240V)
QBC-5000N	Audio Battery Charger
BB-1001D/DR/DS/DB	Remote Annunciator Enclosure Houses one module. "D" White, "DR" Red, "DS" Stainless Steel, or "DB" for Black Door.
BB-1002D/DR/DS/DB	Remote Annunciator Enclosure Houses two module. "D" White, "DR" Red, "DS" Stainless Steel, or "DB" for Black Door.
BB-1003D/DR/DS/DB	Remote Annunciator Enclosure Houses three module. "D" White, "DR" Red, "DS" Stainless Steel, or "DB" for Black Door.
BB-1008D/DR/DB	Remote Annunciator Enclosure Houses eight modules. "D" White, "DR" Red or "DB" for Black Door.
BB-1012D/DR/DB	Remote Annunciator Enclosure Houses twelve modules. "D" White, "DR" Red or "DB" for Black Door.
BB-1001WP(R)A	Weather Protected Enclosure Enclosure Houses one module. White. BB-1001WPRA for red.
BB-1002WP(R)A	Weather Protected Enclosure Enclosure Houses two module. White. BB-1002WPRA for red.

Mounting Brackets	
M500-BK-9	M500 Series Mounting Bracket. Holds up to 9 modules in a BB-5000 Series enclosure.
M500-BK-2	M500 Series Mounting Bracket. Holds up to 2 modules in a BBX-FXMNS enclosure.



Canada

25 Interchange Way Vaughan, ON L4K 5W3
Telephone: (905) 660-4655 | Fax: (905) 660-4113

U.S.A.

4575 Witmer Industrial Estates Niagara Falls, NY 14305
Toll Free: (888) 660-4655 | Fax Toll Free: (888) 660-4113

www.mircom.com

This document is provided by Mircom Technologies Ltd., MGC Systems Corp., or their affiliates, subsidiaries and brands, for convenience or marketing only and does not describe products or services technically. For technical information refer to technical manuals. We do not make representations or warranties regarding this information, including as to completeness or accuracy. We may change these contents at any time and reserve all rights in the contents, including copyrights, trademarks and other intellectual property.

CAT. 5985

Rev. 8